



Flow Measurement & Control

Electronic Positive Displacement Fuel oil meters

ISTEC CORPORATION
5 Park Lake Road, Sparta, NJ 07871
973 383 9888 (Phone)
973 383 9088 (Fax)
Email: sales@istec-corp.com
Web: www.istec-corp.com

Applications

- Flow measurement of mineral oils such as heating or propellant fuels
- In burners, on board ships, land vehicles and fixed installations
- Marine and metrological type approvals (optional)



Features

- The complete range of products offering the best solutions for the measurement of oil consumption
- State-of-the-art design with electronic counter, flow indication, analogue and digital output signals and limiting value switch
- Mounting on the pressure or suction side of a pump, with no straight inlets or outlets required
- Independent of viscosity and temperature
- High vibration resistance
- Classical version with mechanical display still available

Your benefits

- The solution to your flow monitoring application with a complete product offering
- Reliable monitoring and flexible control of the system. Simplifies burner settings and optimising consumption
- Highly flexible mounting with very small space requirements
- Accurate measurements
- Maximum safety in the shipbuilding and automobile industries
- Cost-effective metering point

Istec's 9200 series oil meter is available in 1/2" through 2". This Positive Displacement Oil Meter has an Electronic multifunction display and selectable outputs

Technical data



- display of total, resettable total, and flow rate in m, litres or US gallons
- user-friendly, interactive parameter input
- fuel oil meter with threaded or flanged connections
- for mounting in horizontal or vertical positions

Versions available on request:

- different flange drillings, such as ANSI, JIS

Type		9218	9223	9228	9242	9252
Nominal diameter	Inch(s)	1/2	3/4	1	1 1/2	2
Installation length	inchs	6.5	6.5	7.5	11.8	13.8
Nominal pressure with threaded ends	psia	232	232	232	232	232
	with flanges	psia	362	362	362	362
Maximum temperature	(F)	266	266	266	266	266
Minimum flow rate Q_{min}	g/h	4	8	20	60	200
Nominal flow rate Q_n	g/h	105	265	530	1600	5300
Maximum flow rate Q_{max}	g/h	160	400	800	2400	8000
Approximate starting flow rate	g/h	1	3	8	23	74
Maximum permissible flow rate	+/- 1% of actual flow					
Repeatability	+/- 0.2%					
Safety filter mesh size	mm	0.400	0.400	0.400	0.800	0.800
Dirt filter mesh size	mm	0.250	0.400	0.400	0.600	0.600
Volume of measuring chamber	approx. cm	12	36	100	330	1200
Housing finish	enamelled red RAL 3013					
Weight with thread ends (w/o couplings)	approx. lb	4.8	5.5	9.2	28.1	-
	with flanges	approx. lb	8.3	9.9	16.5	44.7
Smallest readable amount						
Total volume	1	No decimal places				
Resettable volume	1	1 decimal places				
Digital flow rate display	g/h	1 decimal places				
Electronic display capacity	g	100000000				
Time at Q_n until rollover to zero	h	128000	100000	50000	16667	5000
Outputs	2 freely selectable independent of each other					
Pulse value for totalizer	Vol./Pulse	pulse vlaues and width				
Analog for Flowrate	Current	4mA = Min g/h, 20mA=Max g/h				
Limiting Switch	Q_{min} Q_{max}	Minimum, maximum and hysteresis				

Electronic display

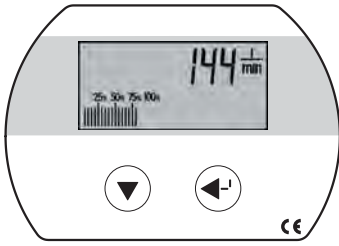

- Display values:
- total volume, resettable volume, flow rate
 - In the information menu, hours of operation and other information can be obtained
- Display:
- 8-character LCD with identification of the parameter, height of numbers: 8 mm, flow rate (meter load) using bar indicator
- Temperature:
- ambient temperature -13 ... +158°F, storage temperature -13 ... +185°F
- Safety:
- CE, vibration and shock test to DIN IEC 68
- Power supply:
- 24 V DC (6...30 V DC)
- Data preservation:
- by non-volatile memory (EEPROM)
- Protection class:
- IP66 (IEC 60529) against water jets and dust

Outputs

Four output functions are available:

- Pulsar for volume pulses with programmable pulse value (for external totaliser)
- Analogue current output 4...20 mA corresponding to flow rate
- Frequency output 0...100 Hz corresponding to flow rate
- Switching function (limiting value switch) specified by programmable upper and lower flow rates

Except for the analogue output function, any two of the remaining three functions can always be used simultaneously. This results in two types of connection:

- 1 potential-free digital output (Rel. 1), programmable to one of the three functions described below.
- 1 passive analogue 4...20 mA output also used for powering the meter.

- 2 potential-free digital outputs (Rel. 1 + Rel. 2), each programmable to one of the three functions described below.
- The analogue output is not available in this case. The power is supplied over these terminals

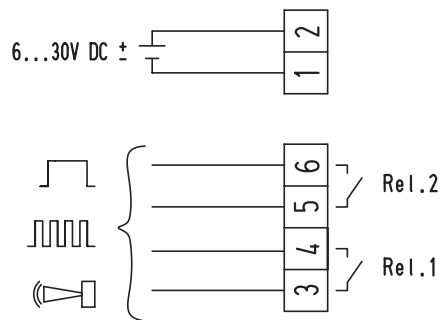
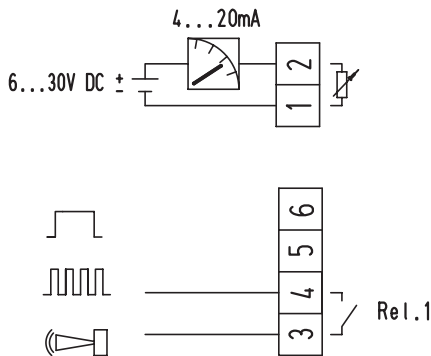

Specification of the outputs

Passive analogue output (1-2)

- Voltage range U: 6...30V DC
- Maximum load R_L : (U-5) V / 0.0215A [Ω]
- Resolution: 16 Bit
- Max. error: ± 0.2 mA
- Update interval: < 1s

Digital outputs (3-4, 5-6)

- Max. voltage U_{max} : 48V AC/DC
- Max. current I_{max} : 50 mA
- Max. output frequency f_{max} : 100 Hz
- Update interval: < 1s
- ON-resistance R_0 : $\leq 100\Omega$
- OFF-resistance R_∞ : $\geq 10M\Omega$
- Insulation voltage: > 100V AC/DC

Adjustable functions:

Volume pulses

- Pulse width t: 5, 50, 250, 500 ms
 Pulse value: 10, 1, 0.1, 0.01, 0.001 pulses/gallon

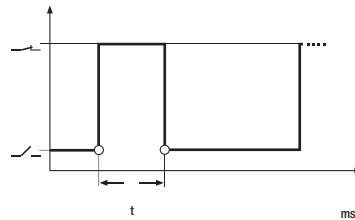

Current signal

- Flow rate at 4 mA Q_1 : > or = 0
- Flow rate 20 mA Q_2 : < or = Q_{max}
- Attenuation: Adjustable 1 - 10

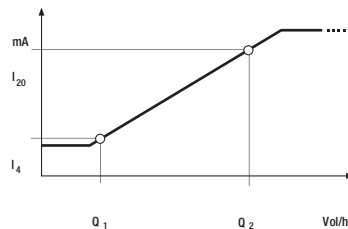

Frequency signal

- Output frequency f_{max} : 100Hz
 Pulse ratio: 1:1
 Frequency / Flowrate f_1/Q_1 : adjustable
 Frequency / Flowrate f_2/Q_2 : adjustable

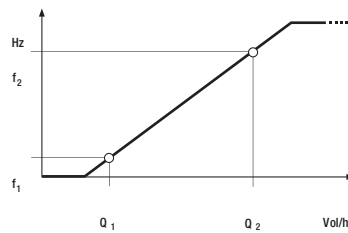

Limiting value switch

- Limit Q_{min} : > or = 0
 Limit Q_{max} : < or = Q_{max}
 Hysteresis H: 0 - 10% of Q_{Lim}

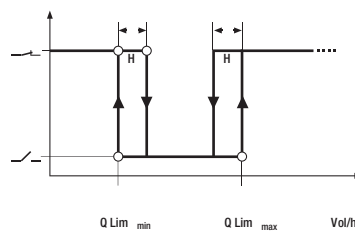

ISTEC
 Flow Measurement & Control

ISTEC CORPORATION
 5 Park Lake Road, Sparta, NJ 07871
 973 383 9888 (Phone)
 973 383 9088 (Fax)
 Email: sales@istec-corp.com
 Web: www.istec-corp.com